

*Buck-Boost Transformers*

*Section*

8



**A simple and economical way to correct offstandard voltages... from 95 to 500 volts; single and three phase, in sizes up to 360 kVA. Simplified buck-boost rating charts make proper transformer selection easy, accurate.**

Description and Applications	118-119
Questions and Answers	120-126
Selection Charts - Single Phase	127-129
Selection Charts - Three Phase	130-132
Specifications	133-135
Wiring Diagrams	135-137
 Three Phase Buck Boost	137

**Where are buck-boost transformers used?**

A typical buck-boost application is 120 volts in, 12 volts out for low voltage lighting or control circuitry. In most applications, this low voltage transformer is field connected as an autotransformer. (See question 2 for the definition of an autotransformer). Buck-boost transformers provide tremendous capabilities and flexibility in kVA sizes and input/output voltage combinations. Basically you get 75 different transformers... all in one convenient package.

Other buck-boost applications are, where (A) low supply voltage exists because equipment is installed at the end of a bus system; (B) the supply system is operating at or over its design capacity; and (C) where overall consumer demands may be so high the utility cuts back the supply voltage to the consumer causing a “brownout.”

**Why use buck-boost instead of another type transformer ?**

Take a look at the advantages and disadvantages of using a buck-boost transformer (autotransformer) compared to a standard isolation transformer of the proper size and voltage combination.

**Proper voltage is critical**

With nearly two-thirds of all electrical loads being A.C. motor loads, maintenance of the proper voltage to that motor is very important. If the supply line voltage is not maintained, motor winding current is increased causing reduced motor torque and escalating motor temperature, all of which results in the rapid loss of insulation life expectancy.

In addition to motor loads, the detrimental effects of low voltage on both resistive heating loads and incandescent lighting output is illustrated in the chart.

Anytime you have a lower than standard voltage, equipment damage and failure can result.

Buck-boost transformers are an economical way to correct this potentially very serious problem. Anytime a line voltage change in the 5-20% range is required, a buck-boost transformer should be considered as your first line of defense.

Advantages	Disadvantages
More efficient	No circuit isolation
Smaller & lighter	Cannot create a neutral
5-10 times increase in kVA	Application voltages and kVA don't match the nameplate voltages and kVA
Versatile, many applications	
Lower cost	



T211688



T111683

**Encapsulated  
Single Phase, .05 to 10.0 kVA****Features**

- UL listed, CSA certified and UL 3R enclosure, meets or exceeds all listing criteria, including NEMA, ANSI, and OSHA standards
- Flexibility, can be used in single phase and three phase configurations
- Reduce (buck) or raise (boost) line voltage from 5 - 20%
- All copper lead wire terminations
- Long Life, 80° C rise up to 0.15 kVA, and 115° C rise above 0.25 kVA
- Can be used in Three Phase applications

**Encapsulated  
Three Phase, 3.0 to 150 kVA** **Features**

- UL listed, CSA certified and UL 3R enclosure, meets or exceeds all listing criteria, including NEMA, ANSI, and OSHA standards
- One unit, instead of multiple for 3 phase applications
- Time and installation cost savings as units come pre-wired from the factory
- Smaller footprint compared to using three individual single phase units
- Long Life, UL class 180° C insulation system, 115° C rise



## HOW LOW VOLTAGE AFFECTS VARIOUS EQUIPMENT OPERATIONS AND FUNCTIONS

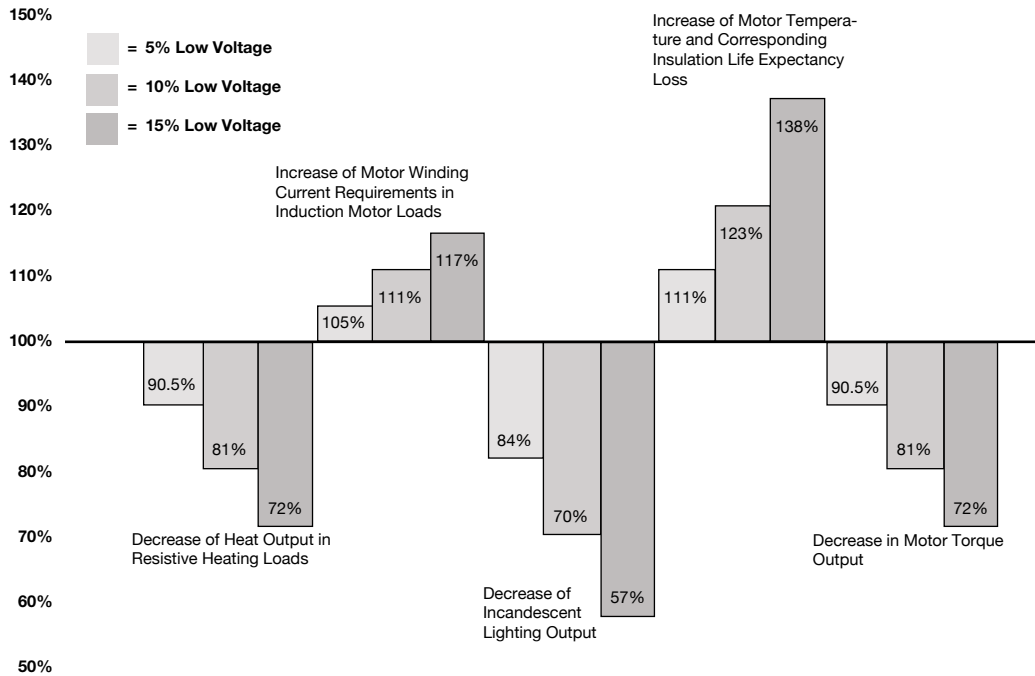

## QUESTIONS AND ANSWERS ABOUT BUCK-BOOST TRANSFORMERS

### 1. What is a buck-boost transformer?

Buck-boost transformers are small single phase transformers designed to reduce (buck) or raise (boost) line voltage from 5-20%. The most common example is boosting 208 volts to 230 volts, usually to operate a 230 volt motor such as an air-conditioner compressor, from a 208 volt supply line.

Buck-boosts are a standard type of single phase distribution transformers, with primary voltages of 120, 240 or 480 volts and secondaries typically of 12, 16, 24, 32 or 48 volts. They are available in sizes ranging from 50 volt amperes to 10 kilo-volt amperes.

Buck-boost transformers are shipped ready to be connected for a number of possible voltage combinations.

### 2. How does a buck-boost transformer differ from an insulating transformer?

A buck-boost transformer IS an insulating type transformer when it is shipped from the factory. When it is connected at the job site, a lead wire on the primary is connected to a lead wire on the secondary – thereby changing the transformer’s electrical characteristics to those of an autotransformer. The primary and secondary windings are no longer “insulated” and secondary windings are no longer “insulated” and its kVA capacity is greatly increased. Refer to figures 1, 2 and 3.

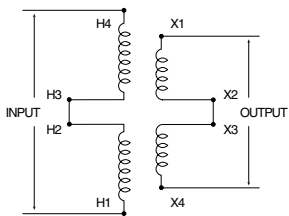

Figure 1. Buck-boost transformer connected as a low voltage insulating transformer (primary and secondary windings shown series connected).

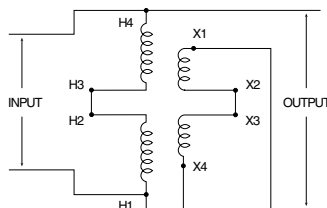

Figure 2. Same buck-boost transformer connected as a boosting autotransformer. The connection from H1 to X4 “converted” the unit to an autotransformer.

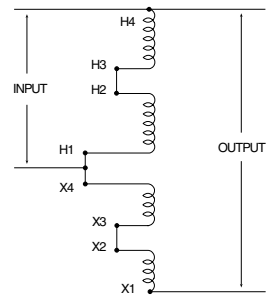

Figure 3. Illustration No. 2 shown with the primary and secondary windings “straightened”.

**3. What is the difference between a buck-boost transformer and an autotransformer?**

When a primary lead wire and secondary lead wire of a buck-boost transformer are connected together electrically, in a recommended voltage bucking or boosting connection, the transformer is in all respects, an autotransformer. However, if the inter-connection between the primary and secondary winding is not made, then the unit is an insulating type transformer.

**APPLICATIONS****4. Why are they used?**

Electrical and electronic equipment is designed to operate on standard supply voltage. When the supply voltage is constantly too high or too low, (usually more than 55%), the equipment fails to operate at maximum efficiency. A buck and boost transformer is a simple and ECONOMICAL means of correcting this off-standard voltage.

**5. What are the most common applications for buck-boost transformers?**

Boosting 208V to 230V or 240V and vice versa for commercial and industrial air conditioning systems; boosting 110V to 120V and 240V to 277V for lighting systems; voltage correction for heating systems and induction motors of all types. Many applications exist where supply voltages are constantly above or below normal.

**6. Can buck-boost transformers be used to power low voltage circuits?**

Yes, low voltage control, lighting circuits, or other low voltage applications requiring either 12V, 16V, 24V, 32V or 48V. The unit is connected as an insulating transformer and the nameplate kVA rating is the transformer's capacity.

**7. Why do buck-boost transformers have 4 windings?**

To make them versatile! A four winding buck-boost transformer (2 primary and 2 secondary windings) can be connected eight different ways to provide a multitude of voltage and kVA outputs. A two winding (1 primary & 1 secondary) buck-boost transformer can be connected only one way.

**8. Will a buck-boost transformer stabilize voltage?**

No. The output voltage is a function of the input voltage. If the input voltage varies, then the output voltage will also vary by the same percentage.

**LOAD DATA****9. Are there any restrictions on the type of load that can be operated from a buck-boost transformer?**

No, there are no restrictions.

**10. Why can a buck-boost transformer operate a kVA load many times larger than the kVA rating on its nameplate?**

Since the transformer has been auto-connected in such a fashion that the 22V secondary voltage is added to the 208V primary voltage, it produces 230V output.

The autotransformer kVA is calculated:

$$\text{kVA} = \frac{\text{Output Volts} \times \text{Secondary Amps}}{1000}$$

$$\text{kVA} = \frac{230 \text{ V} \times 41.67 \text{ Amps}}{1000} = 9.58 \text{ kVA}$$



The picture to the left illustrates the difference in physical size between the autotransformer of 1 kVA, capable of handling a 9.58 kVA load, and an isolation transformer capable of handling a 7.5 kVA load.

To cite an example... a model T111683 buck-boost transformer has a nameplate kVA rating of 1 kVA, but when it's connected as an autotransformer boosting 208V to 230V, its kVA capacity increases to 9.58 kVA. The key to understanding the operation of buck-boost transformers lies in the fact that the secondary windings are the only parts of the transformer that do the work of transforming voltage and current. In the example above, only 22 volts are being transformed (boosted) — i.e. 208V + 22V = 230V. This 22V transformation is carried out by the secondary windings which are designed to operate at a maximum current of 41.67 amps (determined by wire size of windings).

$$\text{Maximum Secondary Amps} = \frac{\text{Volts} \times \text{Amps} \times 1.73}{\text{Secondary Volts}}$$

$$\begin{aligned} \text{Maximum Secondary Amps} &= \\ \frac{1.0 \text{ kVA} \times 1000}{24\text{V}} &= \\ \frac{1000 \text{ VA}}{24\text{V}} &= 41.67 \text{ Amps} \end{aligned}$$

**11. Can buck-boost transformers be used on motor loads?**

Yes, either single or three phase. Refer to the motor data charts in Section I for determining kVA and Amps required by NEMA standard motors.

**12. How are single phase and three phase load Amps and load kVA calculated?**

$$\text{Single Phase Amps} = \frac{\text{kVA} \times 1000}{\text{Volts}}$$

$$\text{Three Phase Amps} = \frac{\text{kVA} \times 1000}{\text{Volts} \times 1.73}$$

$$\text{Single Phase kVA} = \frac{\text{Volts} \times \text{Amps}}{1000}$$

$$\text{Three Phase kVA} = \frac{\text{Volts} \times \text{Amps} \times 1.73}{1000}$$

**THREE-PHASE**

**13. Can buck-boost transformers be used on three-phase systems as well as single phase systems?**

Yes. A single unit is used to buck or boost single phase voltage — two or three units are used to buck or boost three phase voltage. The number of units to be used in a three-phase installation depends on the number of wires in the supply line. If the three-phase supply is 4 wire Y, use three buck-boost transformers. If the 3-phase supply is 3 wire Y (neutral not available), use two buck-boost transformers. Refer to three-phase selection charts.

**14. Should buck-boost transformers be used to develop a three-phase 4 wire Y circuit from a three-phase 3 wire delta circuit?**

No. A three phase “wye” buck-boost transformer connection should be used only on a 4 wire source of supply. A delta to wye connection does not provide adequate current capacity to accommodate unbalanced currents flowing in the neutral wire of the 4 wire circuit.

3 Phase Connections		
Input (Supply System)	Desired Output Connection	
Delta 3 Wire	WYE 3 or 4 Wire	Do Not Use
Open Delta 3 Wire	WYE 3 or 4 Wire	Do Not Use
WYE 3 or 4 Wire	Closed Delta 3 Wire	Do Not Use
WYE 4 Wire	WYE 3 or 4 Wire	Ok
WYE 3 or 4 Wire	Open Delta 3 Wire	Ok
Closed Delta 3 Wire	Open Delta 3 Wire	Ok

**15. Why isn’t a closed delta buck-boost connection recommended?**

A closed delta buck-boost auto transformer connection requires more transformer kVA than a “wye” or open delta connection and phase shifting occurs on the output. Consequently the closed delta connection is more expensive and electrically inferior to other three-phase connections.

**CONNECTION AND FREQUENCY**

**16. How does the installer or user know how to connect a buck-boost transformer?**

The connection chart packed with each unit shows how to make the appropriate connections. These same connection charts are also shown in this section (page 135-136).

**17. Can 60 Hertz buck-boost transformers be used on a 50 Hertz service?**

No. Acme buck-boost transformers should be operated only at the frequencies recommended. However, units recommended for 50 cycle operation are suitable for 60 cycle operation but not vice versa.

**SELECTION**

**18. How do you select a buck-boost transformer?**

Refer to the selection steps on page 126 for easy 4-step selection, then go to the charts. Also, pages 15 and 17 are helpful for determining buck-boost kVA when only the H.P. rating of a motor is available.

**NAMEPLATE DATA**

**19. Why are buck-boost transformers shipped from the factory as insulating transformers and not preconnected at the factory as autotransformers?**

A four winding buck-boost transformer can be auto connected eight different ways to provide a multitude of voltage and kVA output combinations. The proper transformer connection depends on the user’s supply voltage, load voltage and load kVA. Consequently, it is more feasible for the manufacturer to ship the unit as an insulating transformer and allow the user to connect it on the job site in accordance with the available supply voltage and requirements of his load.

**20. Why is the isolation transformer kVA rating shown on the nameplate instead of the autotransformer kVA rating?**

The kVA rating of a buck-boost transformer when auto connected depends on the amount of voltage buck or boost. Since the amount of voltage buck or boost is different for each connection, it is physically impossible to show all of the various voltage combinations and attainable kVA ratings on the nameplate. A connection chart showing the various attainable single phase and three-phase connections is packed with each unit.



## SAFETY

### 21. Do buck-boost transformers present a safety hazard usually associated with autotransformers?

No. Most autotransformers, if they are not of the buck-boost variety, change voltage from one voltage class to another. (Example 480V to 240V) In a system where one line is grounded, the user thinks he has 240V; yet due to the primary and secondary being tied together, it is possible to have 480V to ground from the 240V output. A buck-boost transformer only changes the voltage a small amount, such as 208V to 240V. This small increase does not represent a safety hazard, as compared to a buck of 480V to 240V.

## SOUND LEVELS

### 22. Are buck-boost transformers as quiet as standard isolation transformers?

Yes. However, an auto-connected buck-boost transformer will be quieter than an isolation transformer capable of handling the same load. The isolation transformer would have to be physically larger than the buck-boost transformer, and small transformers are quieter than larger ones. (Example) 1 kVA — 40 db; 75 kVA — 50 db. (db is a unit of sound measure).

## COST AND LIFE EXPECTANCY

### 23. How does the cost of a buck-boost transformer compare to that of an insulating transformer — both capable of handling the same load?

For the most common buck-boost applications, the dollar savings are generally greater than 75% compared to the use of an insulating type distribution transformer for the same application.

### 24. What is the life expectancy of a buck boost transformer?

The life expectancy of a buck-boost transformer is the same as the life expectancy of other dry type transformers.

## NATIONAL ELECTRICAL CODE

### 25. Your catalog indicates that a buck-boost transformer is suitable for connecting as an AUTOTRANSFORMER. What is the definition of an autotransformer and how does it differ from an isolation transformer?

An autotransformer is a transformer in which the primary (input) and the secondary (output) are electrically connected to each other. An isolation transformer, also known as an insulating transformer, has complete electrical separation between the primary (input) and the secondary (output). This is illustrated in the drawing below.

An autotransformer changes or transforms only a portion of the electrical energy it transmits. The rest of the electrical energy flows directly through the electrical connections between the primary and secondary. An isolation transformer (insulating transformer) changes or transforms all of the electrical energy it transmits.

Consequently, an autotransformer is smaller, lighter in weight, and less costly than a comparable kVA size insulating transformer.

Please refer to Question 27 for additional information on autotransformers.

Buck-boost transformers are frequently field-connected as autotransformers.

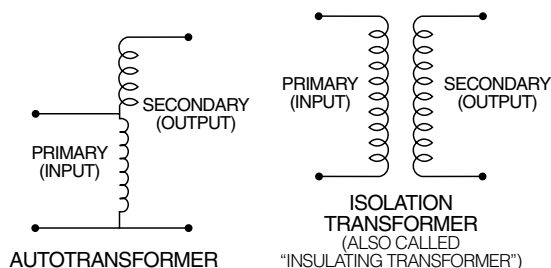
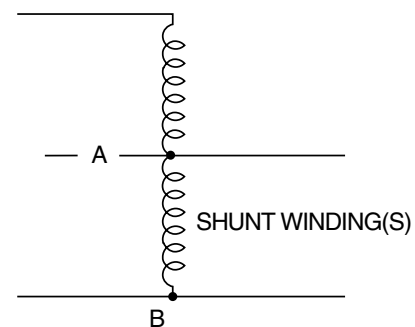

Diagram 450-4



**26. Buck-boost transformers are almost always installed as auto-transformers. Does the N.E.C. (National Electrical Code) permit the use of autotransformers?**

Yes. Please refer to N.E.C. Article 450-4, "Autotransformers 600 Volts, Nominal, or Less." Item (a) explains how to overcurrent protect an autotransformer; item (b) explains that an insulating transformer such as a buck-boost transformer may be field connected as an autotransformer.

**27. When a buck-boost transformer is connected as an autotransformer such as boosting 208V to 230V, the kVA is greatly increased. What is the procedure for determining the size (ampere rating) of the overcurrent protective device such as a fuse or circuit breaker?**

The National Electrical Code Article 450-4 addresses overcurrent protection of autotransformers. A copy is reproduced below for easy reference.

**450-4. Autotransformers 600 Volts, Nominal, or Less.**

(a) Overcurrent Protection. Each autotransformer 600 volts, nominal, or less shall be protected by an individual overcurrent device installed in series with each ungrounded input conductor. Such overcurrent device shall be rated or set at not more than 125 percent of the rated full-load input current of the autotransformer. An overcurrent device shall not be installed in series with the shunt winding (the winding common to both the input and the output circuits) of the autotransformer between Points A and B as shown in Diagram 450-4.

Exception: Where the rated input current of an autotransformer is 9 amperes or more and 125 percent of this current does not correspond to a standard rating of a fuse or non-adjustable circuit breaker, the next higher standard rating described in Section 240-6 shall be permitted. When the rated input current is less than 9 amperes, an overcurrent device rated or set at not more than 167 percent of the input current shall be permitted.

(b) Transformer Field-Connected as an Autotransformer. A transformer field-connected as an autotransformer shall be identified for use at elevated voltage.

**28. I have noted the reprint of the N.E.C. (National Electrical Code), Article 450-4 shown in the previous question covering autotransformer overcurrent protection. Could you explain this article in detail by citing an example?**

An example of an everyday application is always a good way to explain the intent of the "Code." Example: A 1 kVA transformer Catalog No. T111683 has a primary of 120 x 240V and a secondary of 12 x 24V. It is to be connected as an autotransformer at the time of installation to raise 208V to 230V single phase.

When this 1 kVA unit is connected as an autotransformer for this voltage combination, its kVA rating is increased to 9.58 kVA (may also be expressed as 9,580 VA). This is the rating to be used for determining the full load input amps and the sizing of the overcurrent protect device (fuse or breaker) on the input.

$$\text{Full Load Input Amps} = \frac{9,580 \text{ Volt Amps}}{208 \text{ Volts}} = 46 \text{ Amps}$$

When the full load current is greater than 9 amps, the overcurrent protective device (usually a fuse or non-adjustable breaker) amp rating can be up to 125 percent of the full load rating of the autotransformer input amps.

$$\text{Max. amp rating of the overcurrent device} = 46 \text{ amps} \times 125\% = 57.5 \text{ amps}$$

The National Electrical Code, Article 450-4 (a) Exception, permits the use of the next higher standard ampere rating of the overcurrent device. This is shown in Article 240-6 of the N.E.C.

$$\text{Max. size of the fuse or circuit breaker} = 60 \text{ amps}$$



## SELECTING A BUCK-BOOST TRANSFORMER

**You should have the following information before selecting a buck-boost transformer.**

**Line Voltage** — The voltage that you want to buck (decrease) or boost (increase). This can be found by measuring the supply line voltage with a voltmeter.

**Load Voltage** — The voltage at which your equipment is designed to operate. This is listed on the nameplate of the load equipment.

**Load kVA or Load Amps** — You do not need to know both — one or the other is sufficient for selection purposes. This information usually can be found on the nameplate of the equipment that you want to operate.

**Frequency** — The supply line frequency must be the same as the frequency of the equipment to be operated — either 50 or 60 cycles.

**Phase** — The supply line should be the same as the equipment to be operated — either single or three phase.

### Four Step Selection

1. A series of LINE VOLTAGE and LOAD VOLTAGE combinations are listed across the top of each selection chart. Select a LINE VOLTAGE and LOAD VOLTAGE combination from ANY of the charts that comes closest to matching the LINE VOLTAGE and LOAD VOLTAGE of your application.
2. Read down the column you have selected until you reach either the LOAD kVA or LOAD AMPS of the equipment you want to operate. You probably will not find the exact value of LOAD kVA or LOAD AMPS so go to the next higher rating.
3. From this point, read across the column to the far left-hand side and you have found the catalog number of the exact buck-boost transformer you need. Refer to the catalog number listing on page 133 and 135 for dimensions.
4. CONNECT the transformer according to the connection diagram specified at the bottom of the column where you selected YOUR LINE VOLTAGE and LOAD VOLTAGE combination. Connection diagrams are found at the end of this section.

This same connection information is packed with each buck-boost transformer.



Single Phase Application		Boosting									Bucking					
		Line Voltage (Available)									Line Voltage (Available)					
		95	100	105	110	189	208	215	220	125	132	230	245	250	252	
Load Voltage (Output)		114	120	115	120	208	230	237	242	113	120	208	222	227	240	
Catalog Number																
T181047	Load	kVA	0.24	0.25	0.48	0.50	0.43	0.48	0.49	0.50	0.52	0.54	0.47	0.50	0.52	1.02
		Amps	2.08	2.08	4.17	4.17	2.08	2.08	2.08	2.08	4.60	4.60	2.28	2.28	2.28	4.37
	Maximum Size of Fuse or Breaker	6	6	10	10	6	6	6	6	10	10	6	6	6	10	
T181048	Load	kVA	0.47	0.50	0.96	1.01	0.87	0.96	0.99	1.01	1.04	1.08	0.95	1.00	1.04	2.04
		Amps	4.17	4.17	8.33	8.33	4.17	4.17	4.17	4.17	9.20	9.20	4.56	4.56	4.58	8.75
	Maximum Size of Fuse or Breaker	10	10	15	15	10	10	10	10	15	15	10	10	10	15	
T181049	Load	kVA	0.71	0.75	1.43	1.51	1.30	1.43	1.48	1.51	1.56	1.62	1.42	1.50	1.56	3.00
		Amps	6.25	6.25	12.50	12.50	6.25	6.25	6.25	6.25	13.80	13.80	6.86	6.86	6.86	13.10
	Maximum Size of Fuse or Breaker	15	15	20	20	15	15	15	15	20	20	15	15	15	15	
T181050	Load	kVA	1.19	1.25	2.40	2.50	2.16	2.39	2.46	2.52	2.60	2.75	2.37	2.50	2.60	5.10
		Amps	10.42	10.40	20.80	20.80	10.40	10.40	10.40	10.40	22.80	22.80	11.40	11.40	11.40	21.80
	Maximum Size of Fuse or Breaker	25	25	40	30	15	15	15	15	30	30	15	15	15	30	
T181051	Load	kVA	2.37	2.50	4.80	5.00	4.33	4.79	4.93	5.04	5.20	5.40	4.47	5.00	5.20	10.20
		Amps	20.83	20.83	41.67	41.67	20.83	20.83	20.83	20.83	46.80	46.80	22.80	22.80	22.80	43.70
	Maximum Size of Fuse or Breaker	35	35	60	60	30	30	30	30	60	60	30	30	30	60	
T181052	Load	kVA	3.56	3.75	7.17	7.56	6.50	7.19	7.41	7.56	7.80	8.15	7.10	7.50	7.80	15.30
		Amps	31.25	31.25	62.50	62.50	31.25	31.25	31.25	31.25	68.50	69.50	34.40	34.40	34.40	65.50
	Maximum Size of Fuse or Breaker	50	50	90	90	45	45	45	45	80	80	40	40	40	80	
T111683	Load	kVA	4.75	5.00	9.58	10.00	8.66	9.58	9.87	10.00	10.40	10.80	9.50	10.00	10.00	20.40
		Amps	41.67	41.67	83.31	83.31	41.67	41.67	41.67	41.67	91.50	91.50	45.80	45.80	45.80	87.50
	Maximum Size of Fuse or Breaker	70	70	125	125	60	60	60	60	110	110	60	60	50	110	
T111684	Load	kVA	7.12	7.50	14.40	15.10	13.00	14.30	14.80	15.10	15.00	16.20	14.24	15.00	15.60	30.60
		Amps	62.50	62.50	125.00	125.00	62.50	62.50	62.50	62.50	138.00	138.00	68.60	68.60	68.60	132.00
	Maximum Size of Fuse or Breaker	100	100	175	175	90	90	90	90	150	175	80	80	80	175	
T111685	Load	kVA	9.50	10.00	19.20	20.20	17.30	19.16	19.70	20.10	20.80	21.60	19.00	20.00	20.30	40.80
		Amps	83.30	83.30	166.60	166.60	83.30	83.30	83.30	83.30	183.00	183.00	91.60	91.60	91.20	175.00
	Maximum Size of Fuse or Breaker	125	125	250	250	125	125	125	125	225	225	110	110	110	225	
T111686	Load	kVA	14.20	15.00	28.80	30.00	26.00	28.70	29.60	30.30	31.20	32.50	28.50	30.00	31.20	61.00
		Amps	125.00	125.00	250.00	250.00	125.00	125.00	125.00	125.00	275.00	275.00	136.80	136.80	136.80	263.00
	Maximum Size of Fuse or Breaker	200	200	350	350	175	175	175	175	350	350	175	175	175	350	
T111687	Load	kVA	23.70	25.00	47.90	50.00	43.30	47.80	49.30	50.30	52.00	54.00	47.40	50.00	52.00	102.00
		Amps	208.00	208.00	416.60	416.60	208.00	208.00	208.00	208.00	457.00	457.00	228.00	228.00	228.00	437.00
	Maximum Size of Fuse or Breaker	350	350	600	600	300	300	300	300	600	600	300	300	300	600	
T111688 ①	Load	kVA	35.60	37.50	71.90	75.60	65.00	71.80	74.00	75.60	78.00	81.00	71.00	76.00	78.00	153.00
		Amps	312.50	312.50	625.00	625.00	312.50	312.50	312.50	312.50	688.00	688.00	344.00	344.00	344.00	655.00
	Maximum Size of Fuse or Breaker	500	500	1000	1000	450	450	450	450	800	800	400	400	400	800	
T111689 ①	Load	kVA	47.50	50.00	95.80	100.00	86.60	95.80	98.70	101.00	104.00	108.00	95.00	100.00	104.00	204.00
		Amps	416.60	416.60	833.30	833.30	416.60	416.60	416.60	416.60	915.00	915.00	458.00	458.00	458.00	875.00
	Maximum Size of Fuse or Breaker	700	700	1200	1200	600	600	600	600	1200	1200	600	600	600	1200	

See Page 135 for Connection Diagrams      **D   D   C   C   H   H   H   H   F   F   I   I   I   E**

① See chart on page 134, for number of leads per termination.

NOTE: Inputs and Outputs may be reversed; kVA capacity remains constant. All applications above bold face line are suitable for 50/60 Hz. All applications below bold face line are suitable for 60 Hz only.

With larger kVA buck-boost units, it is necessary to utilize multiple conductors on the secondary (X) terminals as shown in the chart on page 134.



Single Phase Application

Line Voltage (Available)

Load Voltage (Output)

Boosting								
95	100	105	208	215	215	220	225	
120	114	119	240	244	230	235	240	

Bucking					
135	240	240	245	250	255
119	208	225	230	234	239

Catalog Number

Catalog Number	Load	kVA	Boosting								Bucking						
			0.19	0.36	0.37	0.38	0.38	0.72	0.73	0.75	0.42	0.37	0.75	0.77	0.78	0.80	
T181054	Load	Amps	1.56	3.13	3.13	1.56	1.56	3.13	3.13	3.13	3.13	3.54	1.77	3.33	3.33	3.33	3.33
		Maximum Size of Fuse or Breaker	6	6	6	6	6	6	6	6	6	6	3	6	6	6	6
	Maximum Size of Fuse or Breaker	6	6	6	6	6	6	6	6	6	6	6	3	6	6	6	6
T181055	Load	kVA	0.38	0.71	0.74	0.75	0.76	1.44	1.47	1.50	0.84	0.74	1.50	1.53	1.56	1.59	1.59
		Amps	3.13	6.25	6.25	3.13	3.13	6.25	6.25	6.25	6.25	7.08	3.54	6.67	6.67	6.67	6.67
	Maximum Size of Fuse or Breaker	10	15	6	6	15	15	15	15	15	15	6	15	15	15	15	15
T181056	Load	kVA	0.56	1.07	1.12	1.13	1.14	2.16	2.20	2.25	1.26	1.11	2.25	2.30	2.34	2.39	2.39
		Amps	4.69	9.38	9.38	4.69	4.69	9.38	9.38	9.38	10.63	5.31	10.00	10.00	10.00	10.00	10.00
	Maximum Size of Fuse or Breaker	10	15	15	10	10	15	15	15	15	15	6	15	15	15	15	15
T181057	Load	kVA	0.94	1.78	1.86	1.88	1.91	3.59	3.67	3.75	2.11	1.84	3.75	3.83	3.90	3.98	3.98
		Amps	7.81	15.63	15.63	7.81	7.81	15.63	15.63	15.63	17.71	8.85	16.67	16.67	16.67	16.67	16.67
	Maximum Size of Fuse or Breaker	15	25	25	15	15	25	25	25	25	20	15	20	20	20	20	20
T181058	Load	kVA	1.88	3.56	3.72	3.75	3.81	7.19	7.34	7.50	4.21	3.68	7.50	7.67	7.80	7.97	7.97
		Amps	15.63	31.25	31.25	15.63	15.63	31.25	31.25	31.25	35.42	17.71	33.33	33.33	33.33	33.33	33.33
	Maximum Size of Fuse or Breaker	25	45	45	25	25	45	45	45	45	40	20	40	40	40	40	40
T181059	Load	kVA	2.81	5.34	5.58	5.63	5.72	10.78	11.02	11.25	6.32	5.53	11.25	11.50	11.70	11.95	11.95
		Amps	23.44	46.88	46.88	23.44	23.44	46.88	46.88	46.88	53.13	26.56	50.00	50.00	50.00	50.00	50.00
	Maximum Size of Fuse or Breaker	40	70	70	40	40	70	70	70	70	60	30	60	60	60	60	60
T113073	Load	kVA	3.75	7.13	7.44	7.50	7.63	14.38	14.69	15.00	8.43	7.37	15.00	15.33	15.60	15.93	15.93
		Amps	31.25	62.50	62.50	31.25	31.25	62.50	62.50	62.50	70.83	35.42	66.67	66.67	66.67	66.67	66.67
	Maximum Size of Fuse or Breaker	50	90	90	50	50	90	90	90	90	80	40	80	80	80	80	80
T113074	Load	kVA	5.63	10.69	11.16	11.25	11.44	21.56	22.03	22.50	12.64	11.05	22.50	23.00	23.40	23.90	23.90
		Amps	46.90	93.80	93.80	46.90	46.90	93.80	93.80	93.80	106.30	53.10	100.00	100.00	100.00	100.00	100.00
	Maximum Size of Fuse or Breaker	80	150	150	70	70	125	125	125	125	125	60	125	125	125	125	125
T113075	Load	kVA	7.50	14.25	14.88	15.00	15.25	28.75	29.38	30.00	16.86	14.73	30.00	30.67	31.20	31.87	31.87
		Amps	62.50	125.00	125.00	62.50	62.50	125.00	125.00	125.00	141.70	70.80	133.30	133.30	133.30	133.30	133.30
	Maximum Size of Fuse or Breaker	100	200	200	90	90	175	175	175	175	175	80	175	175	175	175	175
T113076	Load	kVA	11.25	21.38	22.31	22.50	22.88	43.13	44.06	45.00	25.29	22.10	45.00	46.00	46.80	47.80	47.80
		Amps	93.80	187.50	187.50	93.80	93.80	187.50	187.50	187.50	212.50	106.30	200.00	200.00	200.00	200.00	200.00
	Maximum Size of Fuse or Breaker	150	300	300	150	150	250	250	250	250	250	125	250	250	250	250	250
T113077	Load	kVA	18.75	35.63	37.19	37.50	38.13	71.88	73.44	75.00	42.15	36.83	75.00	76.67	78.00	79.67	79.67
		Amps	156.30	312.50	312.50	156.30	156.30	312.50	312.50	312.50	354.20	177.10	333.30	333.30	333.30	333.30	333.30
	Maximum Size of Fuse or Breaker	250	450	450	225	225	450	450	450	450	400	200	400	400	400	400	400
T213078 ①	Load	kVA	28.10	53.40	55.80	56.30	57.20	107.80	110.20	112.50	63.20	55.30	112.50	115.00	117.00	119.50	119.50
		Amps	234.40	468.80	468.80	234.40	234.40	468.80	468.80	468.80	531.30	265.60	500.00	500.00	500.00	500.00	500.00
	Maximum Size of Fuse or Breaker	400	700	700	350	350	700	700	700	700	600	300	600	600	600	600	600
T213079 ①	Load	kVA	37.50	71.30	74.40	75.00	76.30	143.80	146.90	150.00	84.30	73.70	150.00	153.30	156.00	159.30	159.30
		Amps	312.50	625.00	625.00	312.50	312.50	625.00	625.00	625.00	708.30	354.20	666.70	666.70	666.70	666.70	666.70
	Maximum Size of Fuse or Breaker	500	1000	1000	450	450	1000	1000	1000	1000	800	400	800	800	800	800	800

See Page 135 for Connection Diagrams D C C H H G G G F I E E E E

① See chart on page 134, for number of leads per termination.

NOTE: Inputs and Outputs may be reversed; kVA capacity remains constant. All applications above bold face line are suitable for 50/60 Hz. All applications below bold face line are suitable for 60 Hz only. With larger kVA buck-boost units, it is necessary to utilize multiple conductors on the secondary (X) terminals as shown in the chart on page 134.



Single Phase Application		Boosting										Bucking				
		Line Voltage (Available)										Line Voltage (Available)				
		230	380	416	425	430	435	440	440	450	460	277	480	480	504	
		Load Voltage (Output)										Load Voltage (Output)				
Catalog Number		277	420	457	467	473	457	462	484	472	483	230	436	456	480	
T181061	Load	kVA	0.29	0.44	0.48	0.49	0.49	0.95	0.96	0.50	0.98	1.01	0.29	0.50	1.05	1.10
		Amps	1.04	1.04	1.04	1.04	1.04	2.08	2.08	1.04	2.08	2.08	1.25	1.15	2.29	2.29
	Maximum Size of Fuse or Breaker	3	3	3	3	3	6	6	3	6	6	3	3	6	6	
T181062	Load	kVA	0.58	0.87	0.95	0.97	0.99	1.90	1.93	1.01	1.97	2.01	0.58	1.00	2.09	2.20
		Amps	2.08	2.08	2.08	2.08	2.08	4.17	4.17	2.08	4.17	4.17	2.50	2.29	4.58	4.58
	Maximum Size of Fuse or Breaker	6	6	6	6	6	10	10	6	10	10	6	6	10	10	
T181063	Load	kVA	0.87	1.31	1.43	1.46	1.48	2.86	2.89	1.51	2.95	3.02	0.86	1.50	3.14	3.30
		Amps	3.13	3.13	3.13	3.13	3.13	6.25	6.25	3.13	6.25	6.25	3.75	3.44	6.88	6.88
	Maximum Size of Fuse or Breaker	10	6	6	6	6	15	15	6	15	15	6	6	15	15	
T181064	Load	kVA	1.44	2.19	2.38	2.43	2.46	4.76	4.81	2.52	4.92	5.03	1.44	2.50	5.23	5.50
		Amps	5.21	5.21	5.21	5.21	5.21	5.21	10.42	5.21	10.42	10.42	6.25	5.73	11.46	11.46
	Maximum Size of Fuse or Breaker	15	10	10	10	10	15	15	10	15	15	10	10	15	15	
T181065	Load	kVA	2.89	4.38	4.76	4.86	4.93	9.52	9.62	5.04	9.83	10.06	2.88	5.00	10.45	11.00
		Amps	10.42	10.42	10.42	10.42	10.42	20.83	20.83	10.42	20.83	20.83	12.50	11.46	22.92	22.92
	Maximum Size of Fuse or Breaker	20	15	15	15	15	30	30	15	30	30	15	15	30	30	
T181066	Load	kVA	4.33	6.56	7.14	7.30	7.39	14.28	14.44	7.56	14.75	15.09	4.31	7.49	15.68	16.50
		Amps	15.63	15.63	15.63	15.63	15.63	31.25	31.25	15.63	31.25	31.25	18.75	17.19	34.38	34.38
	Maximum Size of Fuse or Breaker	25	25	25	25	25	45	45	25	45	45	20	20	45	45	
T137920	Load	kVA	5.77	8.57	9.52	9.73	9.85	19.04	19.25	10.08	19.67	20.13	5.75	9.99	20.90	22.00
		Amps	20.83	20.83	20.83	20.83	20.83	41.67	41.67	20.83	41.67	41.67	25.00	22.92	45.83	45.83
	Maximum Size of Fuse or Breaker	35	30	30	30	30	60	60	30	60	60	30	30	60	60	
T137921	Load	kVA	8.66	13.13	14.28	14.59	14.78	28.56	28.88	15.13	29.50	30.19	8.63	14.99	31.35	33.00
		Amps	31.25	31.25	31.25	31.25	31.25	62.50	62.50	31.25	62.50	62.50	37.50	34.38	68.75	68.75
	Maximum Size of Fuse or Breaker	50	50	45	45	45	90	90	45	90	90	40	40	90	90	
T137922	Load	kVA	11.54	17.50	19.04	19.46	19.71	38.08	38.50	20.17	39.33	40.25	11.50	19.98	41.80	44.00
		Amps	41.67	41.67	41.67	41.67	41.67	83.33	83.33	41.67	83.33	83.33	50.00	45.83	91.67	91.67
	Maximum Size of Fuse or Breaker	70	60	60	60	60	110	110	60	110	110	60	60	110	110	
T137923	Load	kVA	17.31	26.25	28.56	29.19	29.56	57.13	57.75	30.25	59.00	60.38	17.25	29.98	62.70	66.00
		Amps	62.50	62.50	62.50	62.50	62.50	125.00	125.00	62.50	125.00	125.00	75.00	68.80	137.50	137.50
	Maximum Size of Fuse or Breaker	100	90	90	90	90	175	175	90	175	175	80	80	175	175	
T137924	Load	kVA	28.90	43.80	47.60	48.60	49.30	95.20	96.20	50.40	98.30	100.60	28.80	50.00	104.50	110.00
		Amps	104.20	104.20	104.20	104.20	104.20	208.30	208.30	104.20	208.30	208.30	125.00	114.60	229.20	229.20
	Maximum Size of Fuse or Breaker	175	150	150	150	150	300	300	150	300	300	150	150	300	300	
T243570 <sup>①</sup>	Load	kVA	43.30	65.60	71.40	73.00	73.90	142.80	144.40	75.60	147.50	150.90	43.10	74.90	156.80	165.00
		Amps	156.30	156.30	156.30	156.30	156.30	312.50	312.50	156.30	312.50	312.50	187.50	171.90	343.80	343.80
	Maximum Size of Fuse or Breaker	250	225	225	225	225	450	450	225	450	450	200	200	450	450	
T243571 <sup>①</sup>	Load	kVA	57.70	87.50	95.20	97.30	98.50	190.40	192.50	100.80	196.70	201.30	57.50	99.90	209.00	220.00
		Amps	208.30	208.30	208.30	208.30	208.30	416.70	416.70	208.30	416.70	416.70	250.00	229.20	458.30	458.30
	Maximum Size of Fuse or Breaker	350	300	300	300	300	600	600	300	600	600	300	300	600	600	

See Page 135 for Connection Diagrams **D H H H H G G H G G J I E E**  
<sup>①</sup> See chart on page 134, for number of leads per termination.  
 NOTE: Inputs and Outputs may be reversed; kVA capacity remains constant. All applications above bold face line are suitable for 50/60 Hz. All applications below bold face line are suitable for 60 Hz only.  
 With larger kVA buck-boost units, it is necessary to utilize multiple conductors on the secondary (X) terminals as shown in the chart on page 134.



Three Phase Application

Line Voltage (Available)

Load Voltage (Output)

Boosting							
189Y 109	196Y 113	201Y 116	208Y 120	189	208	220	
208	234	240	230	208	230	242	

Bucking				
219	230	250	255	264
208	208	227	232	240

Catalog Number

Catalog Number	Load	kVA	1.50	0.84	0.87	1.66	0.75	0.83	0.87
T181047	Load	Amps	4.17	2.08	2.08	4.17	2.08	2.08	2.08
		Maximum Size of Fuse or Breaker	10	6	6	10	6	6	6
	T181048	Load	kVA	3.00	1.69	1.73	3.32	1.50	1.66
Amps			8.33	4.17	4.17	8.33	4.17	4.17	4.17
Maximum Size of Fuse or Breaker		15	10	10	15	10	10	10	
T181049	Load	kVA	4.50	2.53	2.60	4.98	2.25	2.49	2.62
		Amps	12.50	6.25	6.25	12.50	6.25	6.25	6.25
	Maximum Size of Fuse or Breaker	20	15	15	20	15	15	15	
T181050	Load	kVA	7.51	4.22	4.33	8.30	3.75	4.15	4.37
		Amps	20.83	10.42	10.42	20.83	10.42	10.42	10.42
	Maximum Size of Fuse or Breaker	30	20	20	30	15	15	15	
T181051	Load	kVA	15.01	8.44	8.66	16.60	7.51	8.30	8.73
		Amps	41.67	20.83	20.83	41.67	20.83	20.83	20.83
	Maximum Size of Fuse or Breaker	60	35	35	60	30	30	30	
T181052	Load	kVA	22.52	12.67	12.99	24.90	11.26	12.45	13.10
		Amps	62.50	31.25	31.25	62.50	31.25	31.25	31.25
	Maximum Size of Fuse or Breaker	90	50	50	90	45	45	45	
T111683	Load	kVA	30.02	16.89	17.32	33.20	15.01	16.60	17.46
		Amps	83.33	41.67	41.67	83.33	41.67	41.67	41.67
	Maximum Size of Fuse or Breaker	125	70	70	125	60	60	60	
T111684	Load	kVA	45.03	25.33	25.98	49.80	22.52	24.90	26.20
		Amps	125.00	62.50	62.50	125.00	62.50	62.50	62.50
	Maximum Size of Fuse or Breaker	175	100	100	175	90	90	90	
T111685	Load	kVA	60.04	33.77	34.64	66.40	30.02	33.20	34.93
		Amps	166.67	83.33	83.33	167.67	83.33	83.33	83.33
	Maximum Size of Fuse or Breaker	250	125	125	250	125	125	125	
T111686	Load	kVA	90.07	50.66	51.96	99.59	45.03	49.80	52.39
		Amps	250.00	125.00	125.00	250.00	125.00	125.00	125.00
	Maximum Size of Fuse or Breaker	350	200	200	350	175	175	175	
T111687	Load	kVA	150.11	84.44	86.60	165.99	75.06	82.99	87.32
		Amps	416.67	208.33	208.33	416.67	208.33	208.33	208.33
	Maximum Size of Fuse or Breaker	600	350	350	600	300	300	300	
T211688 ①	Load	kVA	225.17	126.66	129.90	248.98	112.58	124.49	130.99
		Amps	625.00	312.50	312.50	625.00	312.50	312.50	312.50
	Maximum Size of Fuse or Breaker	1000	500	500	1000	450	450	450	
T211689 ①	Load	kVA	300.22	168.87	173.21	331.98	150.11	165.99	174.65
		Amps	833.33	416.67	416.67	833.33	416.67	416.67	416.67
	Maximum Size of Fuse or Breaker	1200	700	700	1200	600	600	600	

1.58	0.83	0.90	0.92	0.95
4.39	2.30	2.29	2.29	2.29
10	6	6	6	6
3.16	1.66	1.80	1.84	1.91
8.77	4.61	4.59	4.58	4.58
15	10	10	10	10
4.74	2.49	2.71	2.76	2.86
13.16	6.91	6.88	6.87	6.88
20	15	15	15	15
7.90	4.15	4.51	4.60	4.76
21.94	11.52	11.47	11.45	11.46
30	15	15	15	15
15.80	8.30	9.02	9.20	9.53
43.87	23.04	22.94	22.90	22.92
60	30	30	30	30
23.71	12.45	13.53	13.80	14.29
65.81	34.56	34.42	34.35	34.38
80	40	40	40	40
31.61	16.60	18.04	18.40	19.05
87.74	46.07	45.89	45.80	45.83
110	60	60	60	60
47.41	24.90	27.06	27.60	28.58
131.61	69.11	68.83	68.70	68.75
175	80	80	80	80
63.22	33.20	36.08	36.81	38.11
175.48	92.15	91.78	91.59	91.67
225	110	110	110	110
94.83	49.80	54.13	55.21	57.16
263.22	138.22	137.67	137.39	137.50
350	175	175	175	175
158.05	82.99	90.21	92.02	95.26
438.70	230.37	229.44	228.99	229.17
600	300	300	300	300
237.07	124.49	135.32	138.02	142.89
658.05	345.55	344.16	343.48	343.75
800	400	400	400	400
316.10	165.99	180.42	184.03	190.53
877.40	460.74	458.88	457.97	458.33
1200	600	600	600	600

Quantity Required

3 3 3 3 2 2 2

2 2 2 2 2

See Page 136 for Connection Diagrams

A-A F-F F-F A-A B-B B-B B-B

C-C E-E E-E E-E E-E

① See chart on page 134, for number of leads per termination.



Three Phase Application			Boosting				
			183Y 106	208Y 120	195	208	225
Line Voltage (Available)							
Load Voltage (Output)			208	236	208	240	240
Catalog Number							
T181054	Load	kVA	1.13	1.28	1.13	0.63	1.30
		Amps	3.13	3.13	3.13	1.56	3.13
		Maximum Size of Fuse or Breaker	6	6	6	3	6
T181055	Load	kVA	2.25	2.55	2.25	1.27	2.60
		Amps	6.25	6.25	6.25	3.13	6.25
		Maximum Size of Fuse or Breaker	15	15	15	6	15
T181056	Load	kVA	3.38	3.83	3.38	1.90	3.90
		Amps	9.38	9.38	9.38	4.69	9.38
		Maximum Size of Fuse or Breaker	15	15	15	10	15
T181057	Load	kVA	5.63	6.39	5.63	3.17	6.50
		Amps	15.63	15.63	15.63	7.81	15.63
		Maximum Size of Fuse or Breaker	25	25	25	15	25
T181058	Load	kVA	11.26	12.77	11.26	6.33	12.99
		Amps	31.25	31.25	31.25	15.63	31.25
		Maximum Size of Fuse or Breaker	45	45	45	25	45
T181059	Load	kVA	16.89	19.16	16.89	9.50	19.49
		Amps	46.88	46.88	46.88	23.44	46.88
		Maximum Size of Fuse or Breaker	70	70	70	35	70
T113073	Load	kVA	22.52	25.55	22.52	12.67	25.98
		Amps	62.50	62.50	62.50	31.25	62.50
		Maximum Size of Fuse or Breaker	90	90	90	45	90
T113074	Load	kVA	33.77	38.32	33.77	19.00	38.97
		Amps	93.75	93.75	93.75	46.88	93.75
		Maximum Size of Fuse or Breaker	150	150	125	70	125
T113075	Load	kVA	45.03	51.10	45.03	25.33	51.96
		Amps	125.00	125.00	125.00	62.50	125.00
		Maximum Size of Fuse or Breaker	200	200	175	90	175
T113076	Load	kVA	67.55	76.64	67.55	38.00	77.94
		Amps	187.50	187.50	187.50	93.75	187.50
		Maximum Size of Fuse or Breaker	300	300	250	150	250
T113077	Load	kVA	112.58	127.74	112.58	63.33	129.90
		Amps	312.50	312.50	312.50	156.25	312.50
		Maximum Size of Fuse or Breaker	450	450	450	225	450
T213078 ①	Load	kVA	166.87	191.61	166.87	94.99	194.86
		Amps	468.75	468.75	468.75	234.38	468.75
		Maximum Size of Fuse or Breaker	700	700	700	350	700
T213079 ①	Load	kVA	225.17	255.48	225.17	126.66	259.81
		Amps	625.00	625.00	625.00	312.50	625.00
		Maximum Size of Fuse or Breaker	1000	1000	1000	450	1000

Quantity Required                    3            3            2            2            2  
 See Page 136                            **A-A    A-A    G-G    B-B    G-G**  
 for Connection Diagrams

① See chart on page 134, for number of leads per termination.

Bucking					
240	245	250	256	265	272
208	230	234	240	234	240
0.56	1.33	1.35	1.39	0.72	0.74
1.56	3.33	3.34	3.33	1.77	1.77
3	6	6	6	3	3
1.13	2.65	2.71	2.77	1.43	1.47
3.13	6.66	6.68	6.67	3.54	3.54
6	15	15	15	6	6
1.69	3.98	4.06	4.16	2.15	2.21
4.69	9.99	10.02	10.00	5.31	5.31
10	15	15	15	10	10
2.81	6.63	6.77	6.93	3.59	3.68
7.81	16.64	16.69	16.67	8.85	8.85
15	20	20	20	15	15
5.63	13.26	13.53	13.86	7.17	7.36
15.63	33.29	33.39	33.33	17.69	17.71
20	40	40	40	20	20
8.44	19.89	20.30	20.78	10.76	11.04
23.44	49.93	50.08	50.00	26.54	26.56
30	60	60	60	30	30
11.26	26.52	27.06	27.71	14.34	14.72
31.25	66.58	66.67	66.67	35.39	35.42
35	80	80	80	40	40
16.89	39.87	40.59	41.57	21.52	22.08
46.88	99.86	100.16	100.00	53.08	53.13
60	125	125	125	60	60
22.52	53.04	54.13	55.43	28.69	29.44
62.50	133.15	133.55	133.33	70.78	70.83
70	175	175	175	80	80
33.77	79.57	81.19	83.14	43.03	44.17
93.75	199.73	200.32	200.00	106.17	106.25
110	250	250	250	125	125
56.29	132.61	135.32	138.56	71.72	73.50
156.25	332.88	333.87	333.33	176.95	176.80
175	400	400	400	200	200
84.44	198.92	202.97	207.85	107.58	110.42
234.38	499.32	500.80	500.00	265.42	265.63
300	600	600	600	300	300
112.58	265.22	270.63	277.13	143.44	147.22
312.50	665.76	667.74	666.67	353.90	354.17
350	800	800	800	400	400

2            2            2            2            2            2  
**D-D    C-C    C-C    C-C    E-E    E-E**





Three Phase Application

Line Voltage (Available)

Load Voltage (Output)

		Boosting								Bucking							
399Y	230	380	430	440	460	460	480	480		440	440	460	460	480	480	500	500
480Y	277	420	473	462	506	483	528	504		400	419	438	418	457	436	455	477

Catalog Number		Boosting										Bucking							
T181061	Load	kVA	0.86	0.76	0.85	1.66	0.91	1.74	0.95	1.82	0.79	1.58	1.66	0.83	1.73	0.86	0.90	1.80	
		Amps	1.04	1.04	1.04	2.08	1.04	2.08	1.04	2.08	1.14	2.18	2.18	1.14	2.18	1.14	1.14	2.18	
		Maximum Size of Fuse or Breaker	3	3	3	6	3	6	3	6	3	6	6	3	6	3	3	6	
T181062	Load	kVA	1.73	1.51	1.70	3.33	1.82	3.48	1.90	3.63	1.59	3.17	3.31	1.66	3.46	1.73	1.80	3.61	
		Amps	2.08	2.08	2.08	4.16	2.08	4.16	2.08	4.16	2.29	4.37	4.37	2.29	4.37	2.29	2.29	4.37	
		Maximum Size of Fuse or Breaker	6	6	6	10	6	10	6	10	6	10	10	6	10	6	6	10	
T181063	Load	kVA	2.60	2.27	2.56	4.99	2.73	5.22	2.85	5.45	2.38	4.75	4.97	2.48	5.19	2.59	2.70	5.41	
		Amps	3.12	3.12	3.12	6.24	3.12	6.25	3.12	6.24	3.43	6.55	6.55	3.43	6.55	3.43	3.43	6.55	
		Maximum Size of Fuse or Breaker	10	6	6	15	6	15	6	15	6	15	15	6	15	6	6	15	
T181064	Load	kVA	4.33	3.78	4.26	8.32	4.56	8.70	4.76	9.08	3.96	7.92	8.28	4.14	8.64	4.32	4.51	9.02	
		Amps	5.20	5.20	5.20	10.40	5.20	10.40	5.20	10.40	5.72	10.92	10.92	5.72	10.92	5.72	5.72	10.92	
		Maximum Size of Fuse or Breaker	15	10	10	15	10	15	10	15	10	15	15	10	15	10	10	15	
T181065	Load	kVA	8.60	7.56	8.52	16.64	9.11	17.40	9.51	18.16	7.93	15.85	16.57	8.28	17.29	8.64	9.02	18.04	
		Amps	10.40	10.40	10.40	20.80	10.40	20.80	10.40	20.80	11.44	21.84	21.84	11.44	21.84	11.44	11.44	21.84	
		Maximum Size of Fuse or Breaker	20	15	15	30	15	30	15	30	15	30	30	15	30	15	15	30	
T181066	Load	kVA	12.90	11.34	12.77	24.97	13.67	26.10	14.27	27.24	11.89	23.77	24.85	12.42	25.93	12.96	13.52	27.07	
		Amps	15.60	15.60	15.60	31.20	15.60	31.20	15.60	31.20	17.16	32.76	32.76	17.16	32.76	17.16	17.16	32.76	
		Maximum Size of Fuse or Breaker	25	25	25	45	25	45	25	45	20	40	40	20	40	20	20	40	
T137920	Load	kVA	17.30	15.12	17.03	33.29	18.23	34.80	19.02	36.31	15.85	31.70	33.14	16.57	34.57	17.28	18.03	36.09	
		Amps	20.80	20.80	20.80	41.60	20.80	41.60	20.80	41.60	22.88	43.68	43.68	22.88	43.68	22.88	22.88	43.68	
		Maximum Size of Fuse or Breaker	35	30	30	60	30	60	30	60	30	60	60	30	60	30	30	60	
T137921	Load	kVA	25.90	22.69	25.55	49.93	27.34	52.20	28.53	54.47	23.78	47.55	49.71	24.85	51.86	25.92	27.05	54.13	
		Amps	31.20	31.20	31.20	62.40	31.20	62.40	31.20	62.40	34.32	65.52	65.52	34.32	65.52	34.32	34.32	65.52	
		Maximum Size of Fuse or Breaker	50	45	45	90	45	90	45	90	40	80	80	40	80	40	40	80	
T137922	Load	kVA	34.60	30.25	34.07	66.58	36.46	69.60	38.04	72.63	31.70	63.40	66.27	33.13	69.15	34.56	36.06	72.18	
		Amps	41.60	41.60	41.60	83.20	41.60	83.20	41.60	83.20	45.76	87.36	87.36	45.76	87.36	45.76	45.76	87.36	
		Maximum Size of Fuse or Breaker	70	60	60	110	60	110	60	110	60	110	110	60	110	60	60	110	
T137923	Load	kVA	52.00	45.45	51.18	100.03	54.69	104.57	57.07	109.12	47.63	95.25	99.57	49.77	103.89	51.92	54.18	108.44	
		Amps	62.50	62.50	62.50	125.00	62.50	125.00	62.50	125.00	68.75	131.25	131.25	68.75	131.25	68.75	68.75	131.25	
		Maximum Size of Fuse or Breaker	100	90	90	175	90	175	90	175	80	175	175	80	175	80	80	175	
T137924	Load	kVA	86.10	75.62	85.17	166.44	91.15	174.01	95.11	181.57	79.26	158.50	165.69	82.83	172.87	86.39	90.16	180.44	
		Amps	104.00	104.00	104.00	208.00	104.00	208.00	104.00	208.00	114.40	218.40	218.40	114.40	218.40	114.40	114.40	218.40	
		Maximum Size of Fuse or Breaker	175	150	150	300	150	300	150	300	150	300	300	150	300	150	150	300	
T243570	Load	kVA	129.30	113.43	127.75	249.66	136.72	261.01	142.67	272.36	118.89	237.75	248.53	124.24	259.31	129.59	135.23	270.66	
		Amps	156.00	156.00	156.00	312.00	156.00	312.00	156.00	312.00	171.60	327.60	327.60	171.60	327.60	171.60	171.60	327.60	
		Maximum Size of Fuse or Breaker	250	225	225	450	225	450	225	450	200	400	400	200	400	200	200	400	
T243571 ①	Load	kVA	173.10	151.25	170.33	332.89	182.29	348.02	190.22	363.15	158.52	317.00	331.37	165.65	345.75	172.78	180.31	360.88	
		Amps	208.00	208.00	208.00	416.00	208.00	416.00	208.00	416.00	228.80	436.80	436.80	228.80	436.80	228.80	228.80	436.80	
		Maximum Size of Fuse or Breaker	350	300	300	600	300	600	300	600	300	600	600	300	600	300	300	600	

Quantity Required 3 2 2 2 2 2 2 2 2 2 2 2 2 2 2 2 2

See Page 136

For Connection Diagrams

F-F B-B B-B G-G B-B G-G B-B G-G E-E C-C C-C E-E C-C E-E E-E C-C

① See chart on page 134, for number of leads per termination.

NOTE: (1) Inputs and Outputs may be reversed; kVA capacity remains constant. All applications above bold face line are suitable for 50/60 Hz. All applications below bold face line are suitable for 60 Hz only. (2) Connection Diagrams A-A and F-F cannot be reverse connected.



**SPECIFICATIONS ① - SINGLE PHASE**

**120 X 240 PRIMARY VOLTS — 12/24 SECONDARY VOLTS — 60 Hz**

Catalog Number	Insulating Transformer Rating	Secondary Maximum Current Output		Height (Inches)(Cm.)	Width (Inches)(Cm.)	Depth (Inches)(Cm.)	Weight (Lbs.)(Kg.)	Dimensional Drawings
		12 V	24 V					
T181047	0.05 kVA	4.16	2.08	6.41 (16.3)	3.14 (8.0)	3.05 (7.7)	4 (1.8)	A
T181048	0.10 kVA	8.32	4.16	7.16 (18.2)	3.89 (9.9)	3.67 (9.3)	5 (2.3)	A
T181049	0.15 kVA	12.52	6.25	7.16 (18.2)	3.89 (9.9)	3.67 (9.3)	7 (3.2)	A
T181050	0.25 kVA	20.80	10.40	8.68 (22.0)	4.08 (10.4)	3.88 (9.9)	10 (4.5)	B
T181051	0.50 kVA	41.60	20.80	9.06 (23.0)	4.37 (11.1)	4.20 (10.7)	15 (6.8)	B
T181052	0.75 kVA	62.50	31.25	9.68 (24.6)	4.75 (12.1)	4.51 (11.5)	19 (8.6)	B
T111683	1.00 kVA	83.20	41.60	10.50 (26.7)	5.50 (14.0)	5.13 (13.0)	24 (10.9)	B
T111684	1.50 kVA	125.00	62.50	11.62 (29.5)	5.50 (14.0)	5.13 (13.0)	30 (13.6)	B
T111685	2.00 kVA	166.00	83.20	13.00 (33.0)	5.50 (14.0)	5.13 (13.0)	38 (17.2)	B
T111686	3.00 kVA	250.00	125.00	11.50 (29.2)	10.31 (26.2)	7.13 (18.1)	55 (24.9)	C
T111687	5.00 kVA	416.60	208.00	14.38 (36.5)	10.31 (26.2)	7.13 (18.1)	75 (34.0)	C
T211688	7.50 kVA	625.00	312.50	20.81 (52.9)	11.12 (28.2)	10.84 (27.5)	125 (56.7)	D
T211689	10.00 kVA	833.00	416.60	20.81 (52.9)	11.75 (29.8)	11.59 (29.4)	160 (72.6)	D

**120 X 240 PRIMARY VOLTS — 16/32 SECONDARY VOLTS — 60 Hz**

Catalog Number	Insulating Transformer Rating	Secondary Maximum Current Output		Height (Inches)(Cm.)	Width (Inches)(Cm.)	Depth (Inches)(Cm.)	Weight (Lbs.)(Kg.)	Dimensional Drawings
		16 V	32 V					
T181054	0.05 kVA	3.12	1.56	6.41 (16.3)	3.14 (8.0)	3.05 (7.7)	4 (1.8)	A
T181055	0.10 kVA	6.25	3.12	7.16 (18.2)	3.89 (9.9)	3.67 (9.3)	5 (2.3)	A
T181056	0.15 kVA	9.38	4.69	7.16 (18.2)	3.89 (9.9)	3.67 (9.3)	7 (3.2)	A
T181057	0.25 kVA	15.60	7.80	8.68 (22.0)	4.08 (10.4)	3.88 (9.9)	10 (4.5)	B
T181058	0.50 kVA	31.20	15.60	9.06 (23.0)	4.37 (11.1)	4.20 (10.7)	15 (6.8)	B
T181059	0.75 kVA	46.90	23.40	9.68 (24.6)	4.75 (12.1)	4.51 (11.5)	19 (8.6)	B
T113073	1.00 kVA	62.50	31.20	10.50 (26.7)	5.50 (14.0)	5.13 (13.0)	24 (10.9)	B
T113074	1.50 kVA	93.70	46.90	11.62 (29.5)	5.50 (14.0)	5.13 (13.0)	30 (13.6)	B
T113075	2.00 kVA	125.00	62.50	13.00 (33.0)	5.50 (14.0)	5.13 (13.0)	38 (17.2)	B
T113076	3.00 kVA	187.50	93.80	11.50 (29.2)	10.31 (26.2)	7.13 (18.1)	55 (24.9)	C
T113077	5.00 kVA	312.00	156.00	14.38 (36.5)	10.31 (26.2)	7.13 (18.1)	75 (34.0)	C
T213078	7.50 kVA	468.00	234.00	20.81 (52.9)	11.12 (28.2)	10.84 (27.5)	125 (56.7)	D
T213079	10.00 kVA	625.00	312.00	20.81 (52.9)	11.75 (29.8)	10.84 (27.5)	160 (72.6)	D

① All units have ground studs for use with non-metallic conduit. All sizes of 0.75 kVA and less are suitable for 50/60 Hertz. Additional field wiring box may be required when using units as autotransformers.

Dimensional Drawings page 135.



**240 X 480 PRIMARY VOLTS — 24/48 SECONDARY VOLTS — 60 Hz**

Catalog Number	Insulating Transformer Rating	Secondary Maximum Current Output		Height (Inches)(Cm.)	Width (Inches)(Cm.)	Depth (Inches)(Cm.)	Weight (Lbs.)(Kg.)	Dimensional Drawings
		24 V	48 V					
T181061	0.05 kVA	2.08	1.04	6.41 (16.3)	3.14 (8.0)	3.05 (7.7)	4 (1.8)	A
T181062	0.10 kVA	4.16	2.08	7.16 (18.2)	3.89 (9.9)	3.67 (9.3)	5 (2.3)	A
T181063	0.15 kVA	6.24	3.12	7.16 (18.2)	3.89 (9.9)	3.67 (9.3)	7 (3.2)	A
T181064	0.25 kVA	10.40	5.20	8.68 (22.0)	4.08 (10.4)	3.88 (9.9)	10 (4.5)	B
T181065	0.50 kVA	20.80	10.40	9.06 (23.0)	4.37 (11.1)	4.20 (10.7)	15 (6.8)	B
T181066	0.75 kVA	31.20	15.60	9.68 (24.6)	4.75 (12.1)	4.51 (11.5)	19 (8.6)	B
T137920	1.00 kVA	41.60	20.80	10.50 (26.7)	5.50 (14.0)	5.13 (13.0)	24 (10.9)	B
T137921	1.50 kVA	62.40	31.20	11.62 (29.5)	5.50 (14.0)	5.13 (13.0)	30 (13.6)	B
T137922	2.00 kVA	83.20	41.60	13.00 (33.0)	5.50 (14.0)	5.13 (13.0)	38 (17.2)	B
T137923	3.00 kVA	125.00	62.50	11.50 (29.2)	10.31 (26.2)	7.13 (18.1)	55 (24.9)	C
T137924	5.00 kVA	208.00	104.00	14.38 (36.5)	10.31 (26.2)	7.13 (18.1)	75 (34.0)	C
T243570	7.50 kVA	312.00	156.00	20.81 (52.9)	11.12 (28.2)	10.84 (27.5)	135 (61.2)	D
T243571	10.00 kVA	416.00	208.00	20.81 (52.9)	11.75 (29.8)	11.59 (29.4)	160 (72.6)	D

**LOW VOLTAGE LIGHTING WIRING DIAGRAMS**

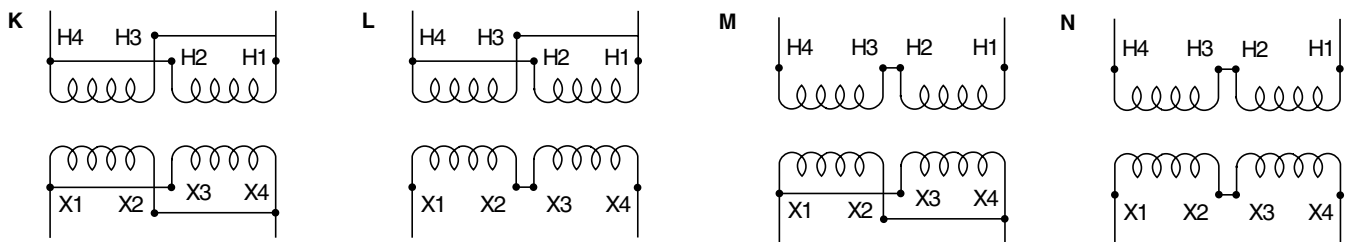

**Units Rated 120 x 240 V Input: 12/24 V Output**

Input	Output	Connection Diagram
120	12	K
120	24	L
240	12	M
240	24	N

**Units Rated 120 x 240 V Input: 16/32 V Output**

Input	Output	Connection Diagram
120	16	K
120	32	L
240	16	M
240	32	N

**Units Rated 240 x 480 V Input: 24/48 V Output**

Input	Output	Connection Diagram
240	24	K
240	48	L
480	24	M
480	48	N

**Number of Leads per Termination**

	H1	H2	H3	H4	X1	X2	X3	X4
T213078	1	1	1	1	2	2	2	2
T213079	1	1	1	1	2	2	2	2
T243571	1	1	1	1	2	2	2	2
T211688	1	1	1	1	2	2	2	2
T211689	1	1	1	1	2	2	2	2

Ⓜ All units have ground studs for use with non-metallic conduit. All sizes of 0.75 kVA and less are suitable for 50/60 Hertz. Additional field wiring box may be required when using units as autotransformers.

Dimensional Drawings page 135.



**BUCK-BOOST DIMENSIONAL DRAWINGS - SINGLE PHASE**

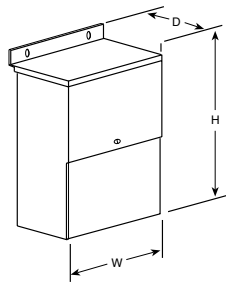

**Design A**

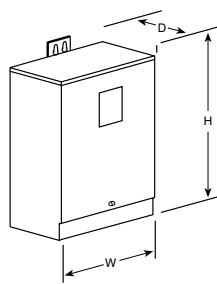

**Design B**

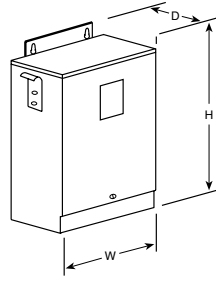

**Design C**

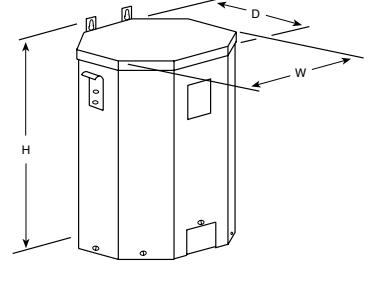

**Design D**

**BUCK-BOOST WIRING DIAGRAMS ① - SINGLE PHASE**

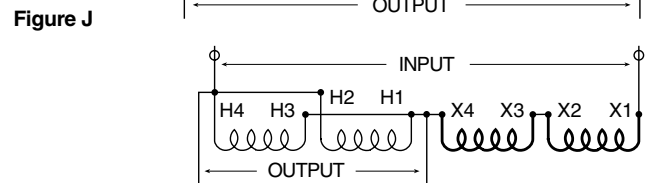
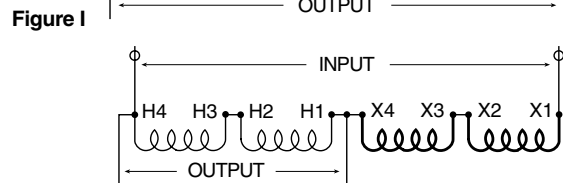
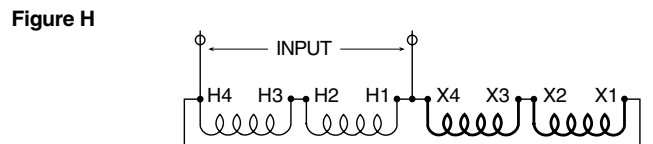
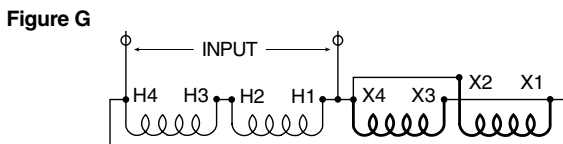
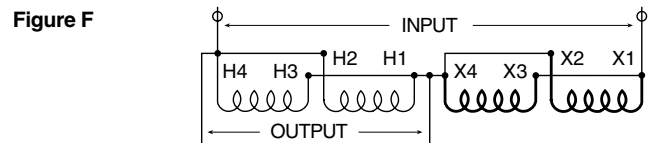
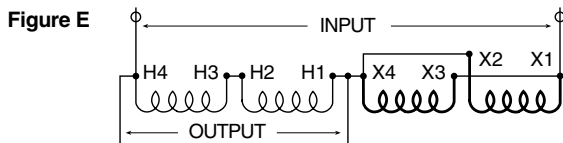
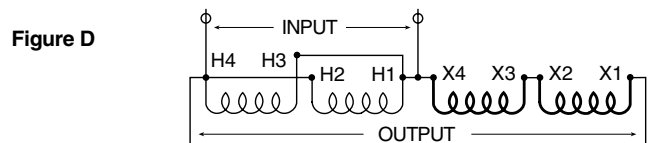
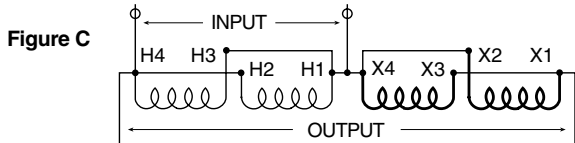

① The symbol O used in these connection diagrams indicates where to field install the over-current protective device, typically a fuse or circuit breaker.

**BUCK-BOOST WIRING DIAGRAMS ① - SINGLE PHASE FOR THREE PHASE APPLICATIONS**

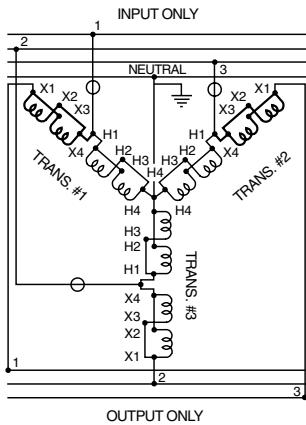

**FIG. AA WYE**

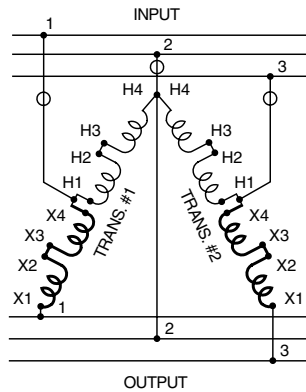

**FIG. BB OPEN DELTA**

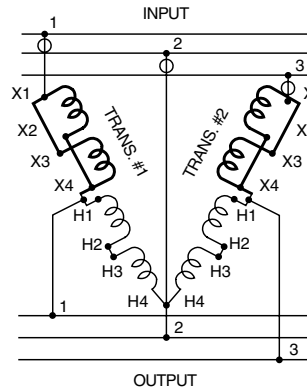

**FIG. CC OPEN DELTA**

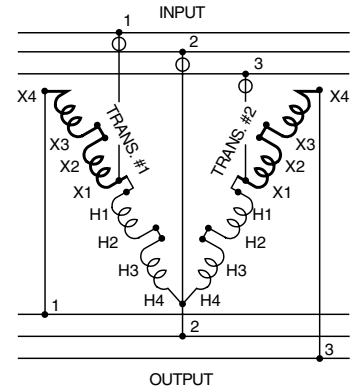

**FIG. DD OPEN DELTA**

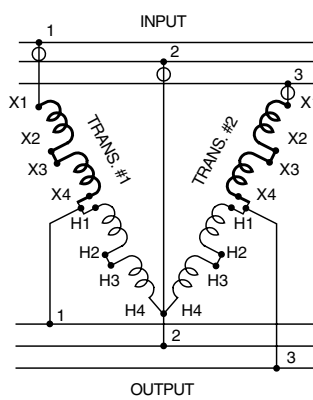

**FIG. EE OPEN DELTA**

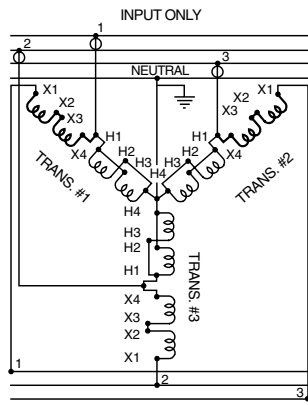

**FIG. FF WYE**

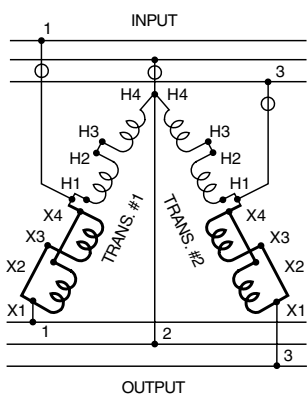

**FIG. GG OPEN DELTA**

- ① The symbol O used in these connection diagrams indicates where to field install the over-current protective device, typically a fuse or circuit breaker.
- ② Cannot be reverse connected.

**IMPORTANT: Refer to the N.E.C. (National Electrical Code) Article 450-4 for overcurrent protection of an autotransformer. These connection diagrams are packed with each buck-boost transformer. Do not use connections other than those shown above.**



## THREE PHASE BUCK-BOOST

Buck Boost transformers are the ideal solution anytime a line voltage change in the 5-15% range is required in single phase or three phase applications.

Until now, three phase applications required multiple separate single phase Buck Boost Transformers to be wired and mounted together. Acme Electric's **NEW 3 Phase Auto Buck Boost Transformers** remove the need for multiple separate units and provide the same great electrical advantages standard Buck Boost Transformers offer in one simple and convenient package.

**Acme Electric's NEW 3 Phase Auto Buck Boost Transformers** are the best economical solutions available for three phase applications, requiring only one transformer and reducing the overall footprint. Additionally, the transformers are assembled and prewired at the factory, a considerable time and installation cost savings.

Acme Electric's **NEW 3 Phase Auto Buck Boost Transformers** are UL Listed with a 10 year warranty and are currently being offered in Type 3R enclosures.

### 240 PRIMARY VOLTS — 208 SECONDARY VOLTS

kVA	Catalog Number	Height (Inches)(Cm.)	Width (Inches)(Cm.)	Depth (Inches)(Cm.)	Weight (Lbs.)(Kg.)	Dimensional Drawing
3	A3003K0310B	15.19(38.6)	13.50(34.3)	10.84(27.5)	120(54.0)	D
6	A3006K0310B	15.19(38.6)	13.50(34.3)	10.84(27.5)	120(54.0)	D
9	A3009K0310B	15.19(38.6)	13.50(34.3)	10.84(27.5)	130(58.5)	D
15	A3015K0310B	15.19(38.6)	13.50(34.3)	10.84(27.5)	130(58.5)	D
30	A3030K0310B	18.86(47.9)	20.30(51.6)	9.03(22.9)	250(112.5)	I
45	A3045K0310B	18.86(47.9)	20.30(51.6)	9.03(22.9)	270(121.5)	I
75	A3075K0310B	24.81(63.0)	27.13(68.9)	11.14(28.3)	400(180.0)	I
112.5	A3112K0310B	24.81(63.0)	27.13(68.9)	11.14(28.3)	600(270.0)	I
150	A3150K0310B	24.81(63.0)	27.13(68.9)	11.14(28.3)	650(292.5)	I

### CONNECTION DIAGRAM

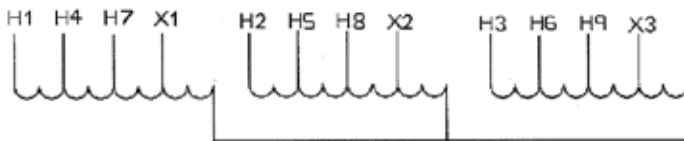

PRIMARY VOLTS	%	CONNECT LEADS TO TAP NO.
252	105	H1-H2-H3
240	100	H4-H5-H6
228	95	H7-H8-H9

SECONDARY LINES TO X1-X2-X3

